

30 W BeO Stripline Terminations



Standards
NF C 96-315
MIL-DTL-39030



Substrate	BeO
Resistive film	Thick film
Tab/Plating	Ag
Mounting flange/Plating	Cu/Ni
Cover substrate	Al ₂ O ₃

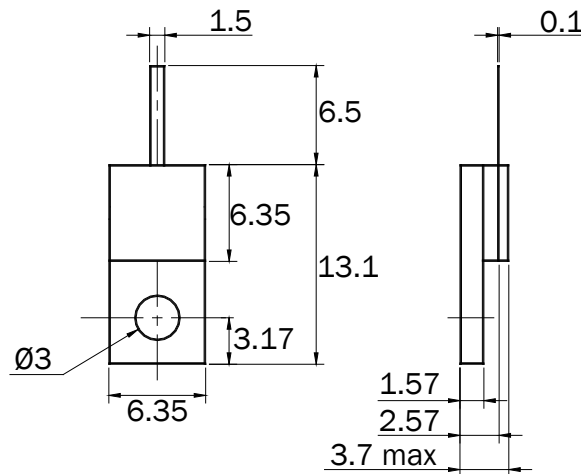
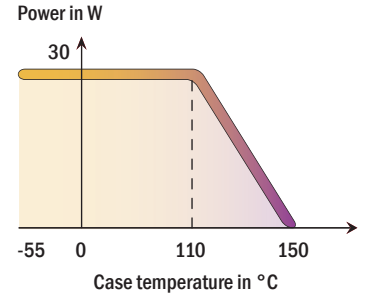

Dimensions in mm

P/N	Frequency (GHz)	Power (W)	Impedance ($\Omega \pm 5\%$)	Max VSWR
17-0596	6	30	50	1.30*
17-0597	6	30	50	1.30*
17-0598	6	30	50	1.30*

* VSWR \leq 1.06 at 2 GHz

mm	inch
0.1	0.004
1.5	0.059
1.57	0.062
2.57	0.101
3	0.118
3.17	0.125
3.7	0.146
6.35	0.250
6.5	0.256
13.1	0.516